

WB-UPS-1100-8

WB-UPS-1500-8

WB-UPS-2000-8

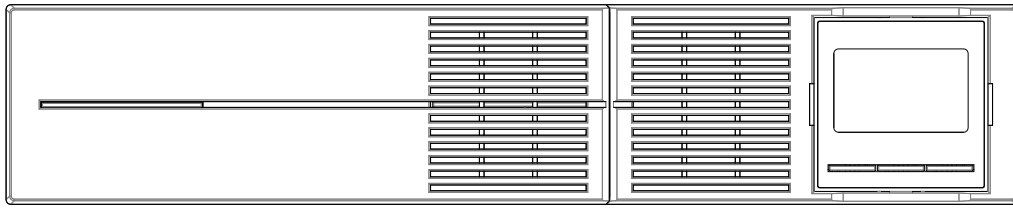

WELCOME TO WATTBOX™

WattBox power products are designed specifically to provide customers with advanced protection for their valuable electronics and custom integrators with maximum flexibility for installation. Rest assured that WattBox products deliver the protection and safety for your customers' needs. All WattBox products are UL certified and built with the highest-quality components available.

KEY FEATURES

Inlet Surge Protection – Built-in protection for the UPS and all connected equipment against power surges.

Automatic Voltage Regulation – Incoming power is monitored to avoid harmful over- or under-voltage conditions. Power is increased in Boost mode and decreased in Buck mode.

Battery Backup – Battery backup for powering critical equipment during power outages and fluctuations. Batteries can be serviced without turning the UPS off.

Programmable Outlets – Noncritical equipment can be connected to programmable outlets that turn off early to save battery power.

Emergency Power Off – Built-in contact for EPO.

PC Connection – Built-in connections for PC access to the GUI and shutdown control to notify the PC when battery level is critical.

SNMP Card (sold separately) – Use the SNMP card to access the GUI over Ethernet and notify devices on the network when the battery level is critical.

IMPORTANT – BATTERIES ARE DISCONNECTED FOR SHIPPING

When you receive your UPS, the internal backup batteries are disconnected from the circuit board for safety during shipping. Re-connect the wires before installing the UPS.

Step 1

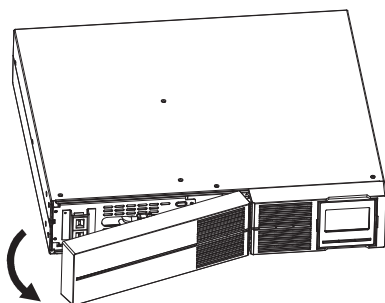

Remove front panel.

Step 2

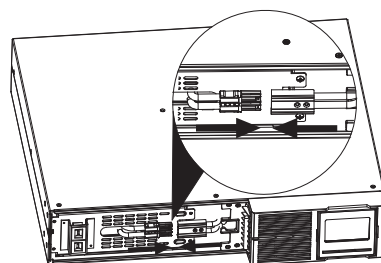

Connect the battery wires.

Step 3

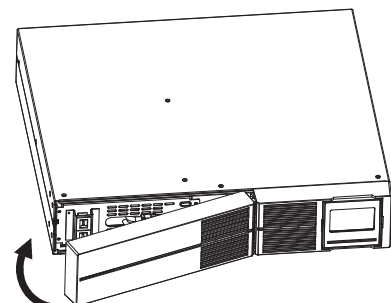

Replace the front panel.

PACKAGE CONTENTS

- | | |
|---------------------------|-----------------------------|
| (1) WB-UPS | (2) Upright mounting bases |
| (1) Owner's manual | (4) Rack mounting brackets |
| (1) Detachable power cord | (8) Mounting bracket screws |
| (1) USB cable | (1) compact disc |

FRONT PANEL

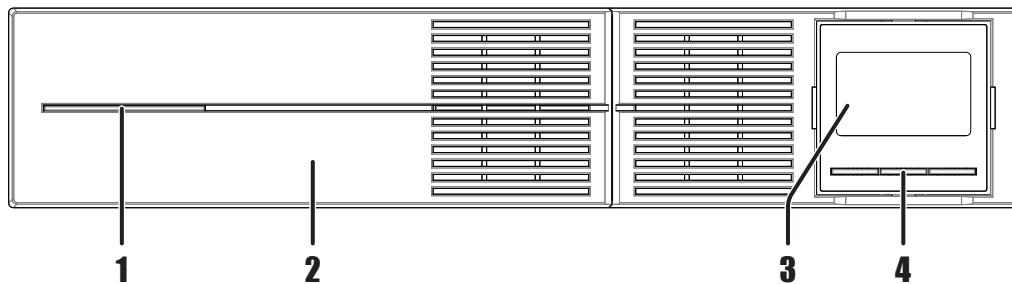

1. Power LED – Illuminates solid blue when the UPS is powered on.
2. Removable Battery Cover – Snap the cover off to access the batteries for connection or replacement.
3. LCD Screen – Used for monitoring and setup of UPS software features.
4. LCD Control Buttons – Used for turning the UPS on and off, navigation and selection in menus, and muting alarm tones.

REAR PANEL (SEE DIAGRAMS ON OPPOSITE PAGE)

1. Circuit Breaker – Resetting circuit breaker that trips out the unit when over-amperage conditions occur.
2. EPO (Emergency Power Off) – Two-pin terminal for turning the UPS on (pins connected) and off (pins separated). Leave the jumper in place if not required.
3. USB Port – Connect an automation system or a computer to control and monitor UPS operation through management software.
4. SNMP Card Slot – Remove the cover to install the optional UPS SNMP Card (not included).
5. Controlled Outlets – Non-critical load outlets that are protected and can be programmed to turn off when the battery level reduces to a set percentage.
6. Uncontrolled Outlets – Critical load outlets that remain on until the UPS battery is depleted.
7. Ground Lug – Ground post for bonding equipment.
8. Power Inlet – Inlet power cord that connects to the supply outlet.
9. RS-232 Port – Connect an automation system or a computer to control and monitor UPS operation through management software.

WB-UPS-1100-8 REAR PANEL

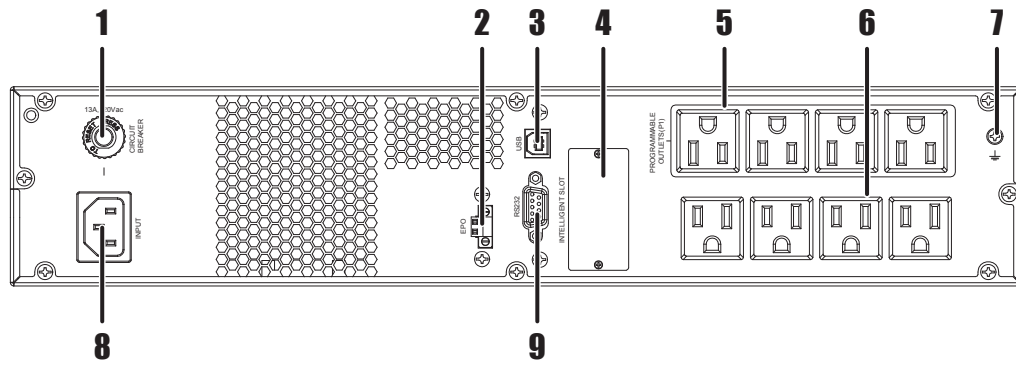

WB-UPS-1500-8 REAR PANEL

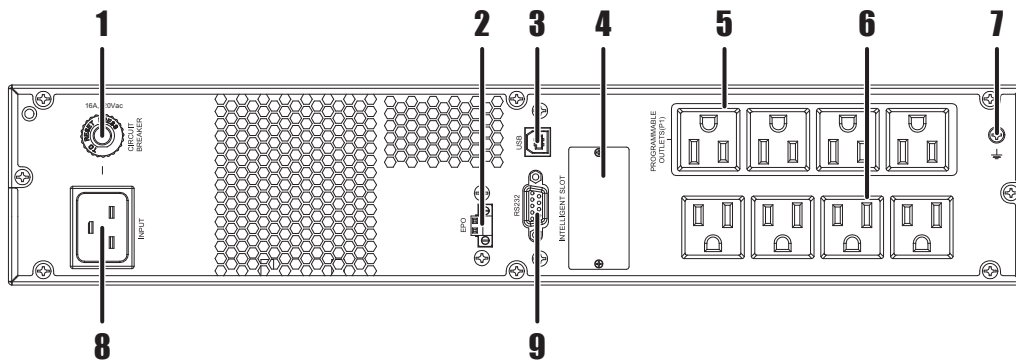

WB-UPS-2000-8 REAR PANEL

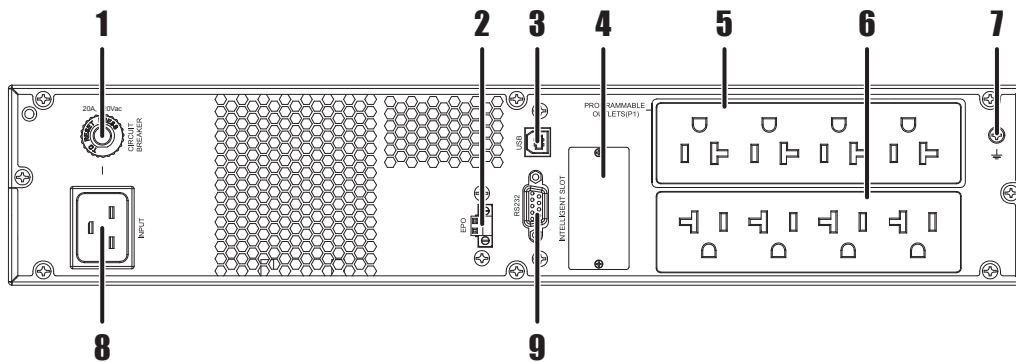

MOUNTING OPTIONS

The WB-UPS is designed for stand-alone applications and also for mounting in standard 19" equipment racks.

Stand-alone Tower

Step 1

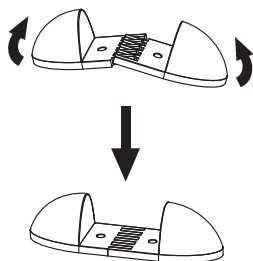

Step 2

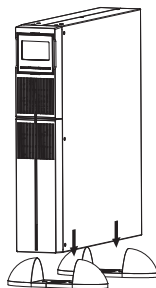

Step 3

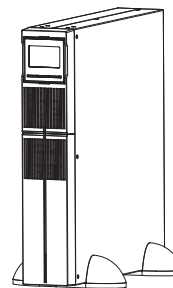

Rack Mounting

Step 1

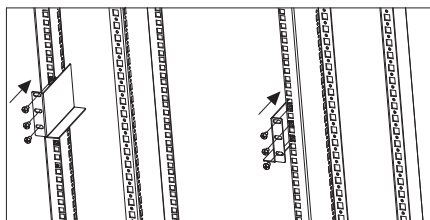

Attach support brackets at the back of the rack.

Step 2

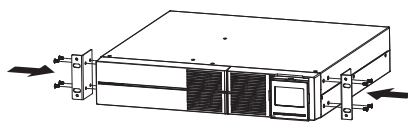

Attach the rack ears to the UPS.



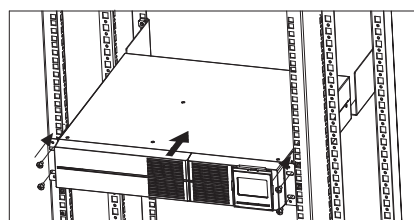

Step 3



Mount the UPS in the rack with the rear of the unit resting on the back brackets.

POWERING THE UPS

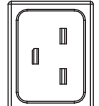
The power outlet for the UPS should be on a dedicated circuit for the best performance. The chart lists the power requirements and outlet required for each UPS model.

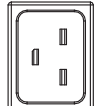
Model	Voltage	Amperage	Outlet Type Required	Power Cord Inlet
WB-UPS-1100-8	120V AC@60 Hz	15A	NEMA 5-15r 	IEC C14 
WB-UPS-1500-8	120V AC@60 Hz	16A	NEMA 5-15r 	IEC C20 
WB-UPS-2000-8	120V AC@60 Hz	20A	NEMA 5-20r 	IEC C20 

CONNECTING EQUIPMENT TO OUTLETS

Critical equipment is connected to the uncontrolled outlets so they remain on until the UPS battery is depleted. Noncritical equipment is connected to controlled outlets so they can be set to turn off once the battery is depleted to a set level. Controlled outlets can also be set to remain on for additional critical loads. Use the remote management connection or the front panel LCD to configure the controlled outlets.

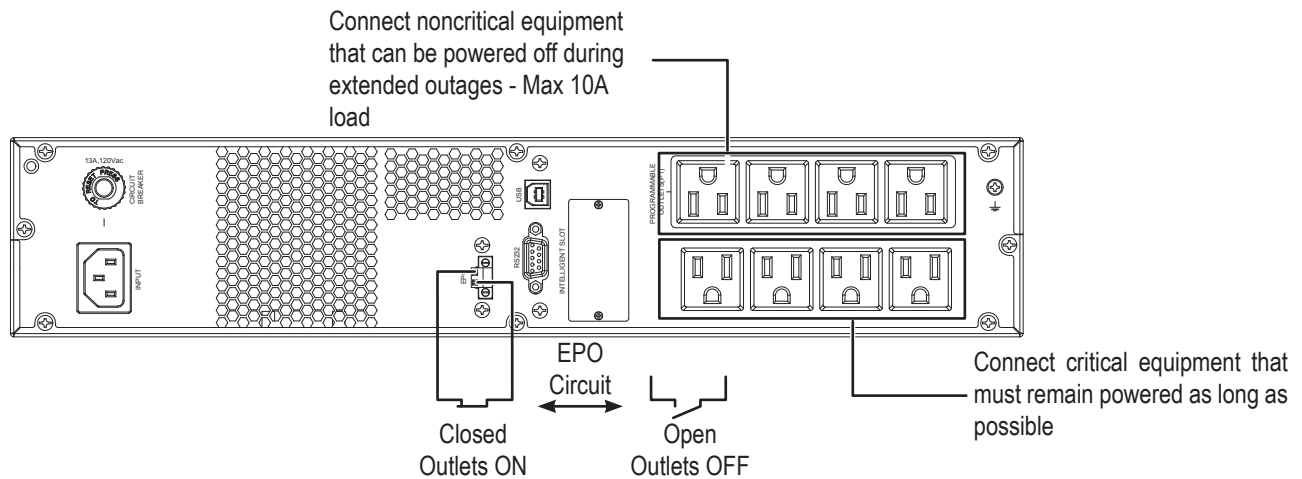

EMERGENCY POWER OFF (EPO)

The EPO feature uses a simple open/closed circuit that, when opened, causes the UPS to immediately shut off power to all outlets. By default, a metal jumper is placed between the contacts of the EPO connector. Remove the jumper and wire a normally closed switch to the connector to use an installed EPO switch.

EPO Reset

To restore normal operation after engaging EPO, the UPS must be turned off and then back on using the front panel LCD buttons.

USB/RS-232 PC CONNECTION

For easy monitoring and configuration of the UPS, plus the ability to shut down the connected computer before the battery depletes.

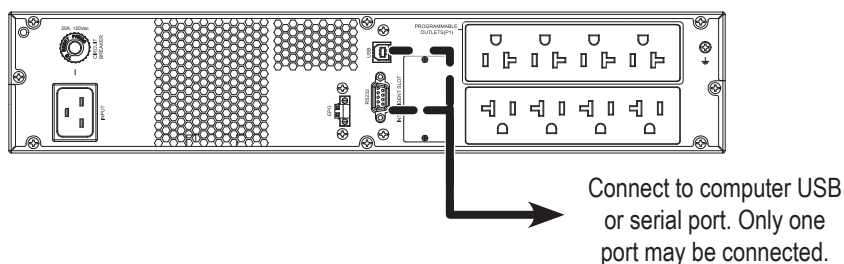

Setup Instructions

1. Install the UPS software on your computer, either from the CD or from the zip download file found on the product page's Support tab. Versions are available for most Windows, Linux, and Mac operating systems.
2. Connect the computer to the UPS using either the included USB cable (recommended) or an RS-232 serial cable.
3. Launch the software. Documentation for the software can be found on the product page's Support tab, on the included CD, or in the software by navigating in the top menu to "Help."

SNMP CARD (SOLD SEPARATELY)

The SNMP card extends communication from the UPS to computers on the network running UPS software. Setup instructions and software are included with the card.

SNMP Card Installation

1. Turn the UPS off (Standby mode) and disconnect the power cord.
2. Remove the SNMP card slot cover.
3. Insert the SNMP card into the slot and secure using the panel cover screws.
4. Connect the SNMP card to the LAN, then power the UPS on. Installation is complete. See the instructions included with the SNMP card for setup and use.

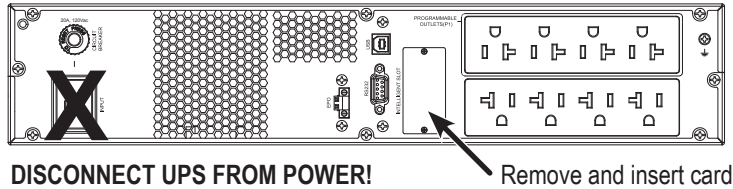

BASIC OPERATION (FRONT PANEL BUTTONS)



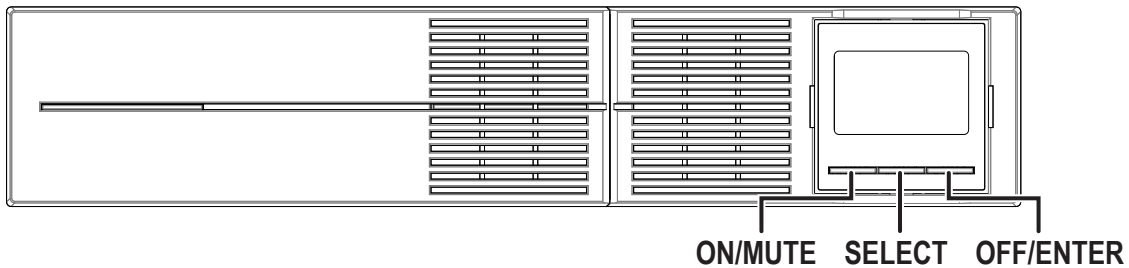





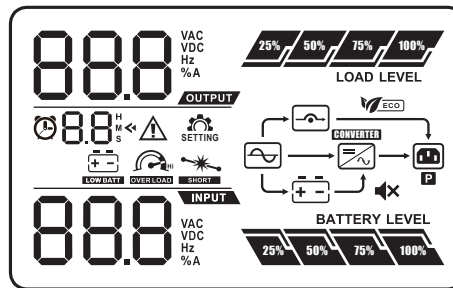



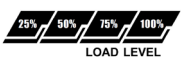

When the unit is plugged into a power outlet, the front panel LCD screen will illuminate and display battery level and input voltage. The UPS outlets will remain off until the unit is powered on using the front panel buttons.



Button	Function	Instructions
ON/MUTE	Power On	Press and hold the ON/MUTE button for two seconds until the UPS beeps and "ON" is displayed on the LCD display. The critical outlets will power on first, followed by the programmable outlets.
	UPS Self Test	With the UPS on and connected to a powered outlet, press and hold the ON/MUTE button for three seconds
	Mute Alarm	With the UPS powered ON and in battery mode, press and hold ON/MUTE for three seconds to disable audible alarms. Note: Mute controls only battery mode alarms. When UPS is powered on, alarms cannot be silenced.
SELECT	LCD Message	Press the SELECT button to toggle between display functions. Options: input voltage, input frequency, battery voltage, output voltage, and output frequency.
	Enter Setup	With the UPS powered off in Standby mode, press and hold the SELECT button for three seconds to enter setup. See setup instructions on page 8.
OFF/ENTER	Power OFF (Standby)	To turn the UPS to Standby mode, press and hold the OFF/ENTER button for three seconds. All UPS outlets will turn off at the same time.

FRONT PANEL LCD OVERVIEW

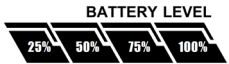



Function	Display	Description
Backup Time	 8.8 ^H .8 ^M _S	Indicates configuration items. See details in “Menu Options” below.
Configuration Info	8.8 ^H .8 ^M _S ◀	The exclamation indicates that a fault has occurred and the associated fault code is displayed below it. See “Fault Codes” on page 10.
Fault/Warning Info	8.8 ^H .8 ^M _S ◀⚠	Indicates warning and fault codes. See sections “Fault Codes” and “Audible Alarms.”
Mute		Indicates that UPS alarm is disabled.
Output	88.8 ^{VAC} VDC Hz %A <small>OUTPUT</small>	Displays output voltage and frequency. VAC=AC voltage; VDC=DC voltage; Hz=Frequency
Load Information		Indicates the connected load level (equipment connected to outlets) in 25% increments.
		Indicates connected device overload.
		Indicates a short circuit in the connected load.
Operating Status		Indicates that the programmable outlets are operating.
		Indicates that the UPS is connected to the main power input.
		Indicates that the battery is working.
		Indicates that bypass mode is working.
		Indicates that the UPS is operating in ECO mode (no voltage correction; line voltage suitable for output).
		Indicates that the inverter circuit is working.
		Indicates that the output is working.
Battery Status		Displays the current battery level in 25% increments.
		Indicates that the battery has a fault.
		Indicates low battery capacity.
Input Information	88.8 ^{INPUT} VAC VDC Hz %A	Displays input voltage, battery voltage, and frequency. VAC=AC voltage; VDC=DC voltage; Hz=Frequency

LCD MENU SETUP (UPS OFF IN STANDBY)

Using the Menu

Action	Instructions
Enter Setup	With the UPS powered off in Standby mode, press and hold SELECT for three seconds to enter Setup.
Menu Navigation	Press ON/MUTE and SELECT to toggle between setup modes 1-7.
Change Setting	Press OFF/ENTER to configure the current setting on the screen. Use ON/MUTE and SELECT to toggle the setting value. Press OFF/ENTER again to save the setting and return to the menu.

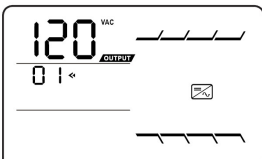

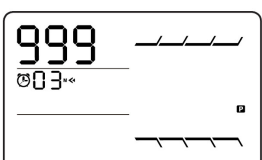
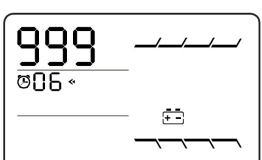
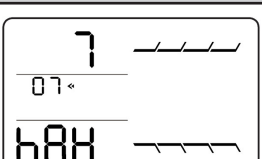
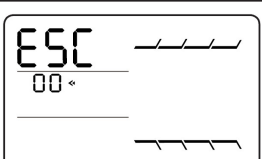

Menu Options

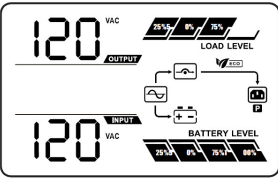
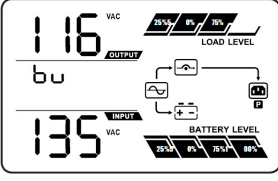
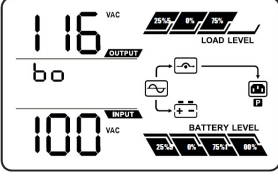
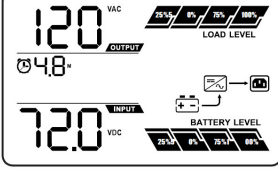
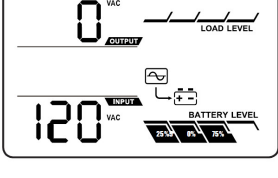
Screen	Instructions
01 Output Voltage	
	Set the output voltage for the UPS outlets in both power and battery mode. Options: 110V AC 115V AC 120V AC (Default) 127V AC
02 Programmable Outlet Enable	
	Set the programmable outlet function. Options: ENA: Enable the programmable outlets to turn off after a set amount of time in battery mode. Use the next menu setting below to select how long the programmable outlets remain on. (Default) DIS: Disable the programmable outlet function. Using this setting, all UPS outlets will remain on battery mode until the battery is depleted.
03 Programmable Outlet Timer	
	This setting is used only when the programmable outlets are enabled. Use the buttons to set the numbers of minutes for the programmable outlets to remain on when the UPS switches to battery mode. Options: 1-999: Number of minutes.
06 Battery Backup Time Limit	
	Set the amount of time that nonprogrammable outlets remain on while in battery backup mode. Options: 0-999: Set the backup time in minutes from 0-999 for uncontrolled outlets on battery mode. DIS: Disable the feature. Backup time will depend on battery level. (Default) Note: When set to "0" the backup time will be ten seconds.
07 Battery Total Amp Hours	
	Set up the battery total amp hours of the UPS. Options: 7-999: Setting the battery total capacity from 7-999 in AH. Be sure to set the correct battery total capacity if an external battery bank is connected.
00 Exit Setup	
	Press OFF/ENTER to exit the Setup menu.









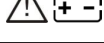

Normal Operating Modes

Mode	Description
ECO Mode	
	ECO (Efficiency Corrective Optimizer) mode is used when the input voltage is within voltage regulation range. The UPS powers the output directly from the mains and disables the internal fan to save energy.
Buck Mode-AC Normal	
	Buck mode is used when the input voltage is higher than the voltage regulation range but lower than the high loss point. The UPS uses the internal auto voltage regulator to step the input power down to the specified output range.
Boost Mode-AC Normal	
	Boost mode is used when the input voltage is lower than the voltage regulation range but higher than the low loss point. The UPS uses the internal auto voltage regulator to step the input power up to the specified output range.
Battery Mode	
	The UPS switches to battery mode when input power is lost, or when the input voltage is beyond the acceptable range for auto voltage regulation (boost or buck mode).
Standby Mode	
	UPS outlets are powered off. Batteries will charge as needed.

FAULT CODES

Fault Code	Icon	Fault Type	Remedy
01	–	Bus start fail	<ol style="list-style-type: none"> 1. Ensure batteries are securely connected. 2. Check battery status. Battery may need to be replaced. 3. If issue persists, contact WattBox Technical Support.
02	–	Bus over	<ol style="list-style-type: none"> 1. Power UPS off, then turn it back on. 2. If issue persists, contact WattBox Technical Support.
03	–	Bus under	<ol style="list-style-type: none"> 1. Ensure batteries are securely connected. 2. Check battery status. Battery may need to be replaced. 3. If issue persists, contact WattBox Technical Support.
11	–	Inverter soft start fail	<ol style="list-style-type: none"> 1. Ensure batteries are securely connected. 2. Power UPS off, then turn it back on. 3. If issue persist, contact WattBox Technical Support.
12	–	Inverter voltage high	<ol style="list-style-type: none"> 1. Contact WattBox Technical Support.
13	–	Inverter voltage low	<ol style="list-style-type: none"> 1. Power UPS off, then turn it back on. 2. If issue persists, contact WattBox Technical Support.
14		Inverter output short	<ol style="list-style-type: none"> 1. Check cables of connected devices and the status of the connected devices. A connected device may be causing the problem. 2. Remove load from UPS and restart it. 3. If issue persists, contact WattBox Technical Support.
27		Battery voltage too high	<ol style="list-style-type: none"> 1. Ensure batteries are securely connected. 2. Remove UPS power cord, then plug it back in. 3. If issue persists, contact WattBox Technical Support.
28		Battery voltage too low	<ol style="list-style-type: none"> 1. Ensure batteries are securely connected. 2. Remove UPS power cord, then plug it back in. 3. If issue persists, contact WattBox Technical Support.
41	–	Over safe operating temperature	<ol style="list-style-type: none"> 1. Contact WattBox Technical Support.
43		Overload	<ol style="list-style-type: none"> 1. Remove excess load until within specification, then restart the UPS.
45	–	Charger failure	<ol style="list-style-type: none"> 1. Contact WattBox Technical Support.

AUDIBLE ALARMS

Description	Icon	Alarm	Remedy
Low Battery/ Battery Fault		One beep per second	Let batteries charge. If charging does not solve the problem, contact WattBox Technical Support.
Overload		Two beeps per second	Reduce the connected load on the UPS outlets.
Battery Not Connected		One beep per second	Remove the front panel and reconnect the battery harness.
Overcharge		One beep per second	Contact WattBox Technical Support.
Site Wiring Fault		One beep per second	Hot and neutral wires are reversed in the UPS outlet. Have an electrician correct the wiring.
EPO Enable		One beep per second	EPO circuit is open. See "EPO" section on page 5.
Over Temperature		One beep per second	Out of safe operating range. Let the UPS cool. Increase ventilation.
Charger Failure		One beep per second	Contact WattBox Technical Support.
EEPROM Error		One beep per second	Contact WattBox Technical Support.
Battery Replacement		One beep per second	Replace all batteries. Contact WattBox Technical Support.

LCD ABBREVIATIONS

Display	Meaning
<i>ENR</i>	Enable
<i>di S</i>	Disable
<i>ESC</i>	Escape
<i>Bu</i>	Buck Mode

Display	Meaning
<i>EP</i>	EPO
<i>LP</i>	Temperature
<i>bt</i>	Battery Replacement
<i>bo</i>	Boost Mode

TROUBLESHOOTING

Symptom	Possible Cause	Remedy
The UPS behaves as if power is out, but power at the outlet is normal.	The power cord is loose or damaged.	Check the power cord connection to the outlet and to the UPS.
The fan is running constantly.	AVR is correcting output voltage, in battery mode, high load connected to UPS outlets.	Check the LCD panel for UPS status. Have an electrician check the power connection and quality of power.
The UPS is emitting an audible alarm.	UPS operating mode issue.	See the opposite page for alarm meaning and remedy.
There is a fault code on the UPS screen.	UPS operating mode issue.	See the opposite page for code meaning and remedy.

Contact Technical Support - Phone: (866) 838-5052 Email: TechSupport@WattBoxPower.com

OPERATING PRINCIPLE

The UPS is composed of mains input, EMI/RFI filters, inverter, battery charger, DC-to-DC converter, battery, AVR TX, and UPS output.

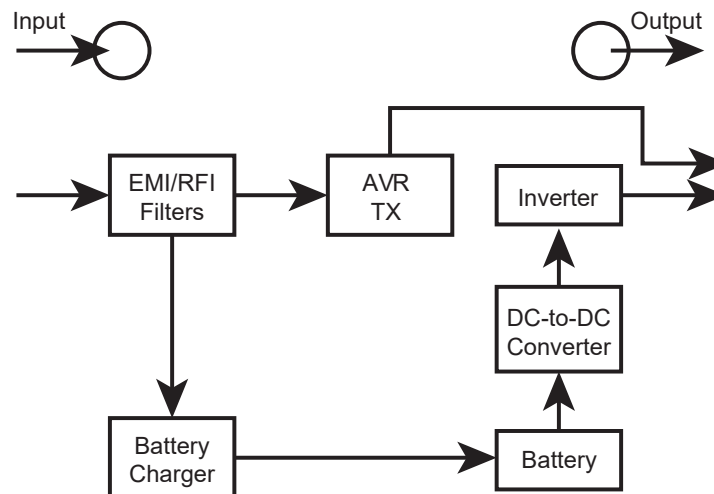

BATTERY REPLACEMENT (SERVICE PERSON ONLY)

The UPS is equipped with user-replaceable batteries that can be hot-swapped while connected equipment is powered from the supply outlet. Contact WattBox Support to order replacement batteries.

Note: With the batteries disconnected for replacement, connected equipment is not protected from power outages.

Note: This UPS is equipped with internal batteries and only the service person can replace the batteries.

BATTERY ACCESS

Step 1

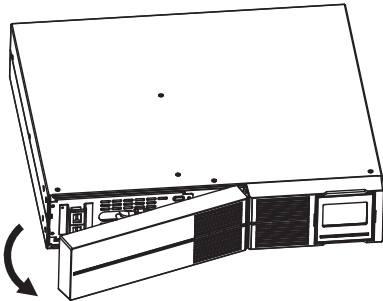

Remove the front panel cover.

Step 2

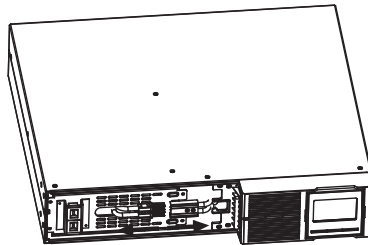

Disconnect the battery wires.

Step 3

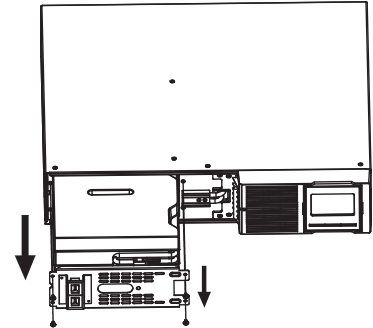

Remove the four battery panel screws, set the cover aside, and pull the battery tray from the front of the UPS.

Step 4

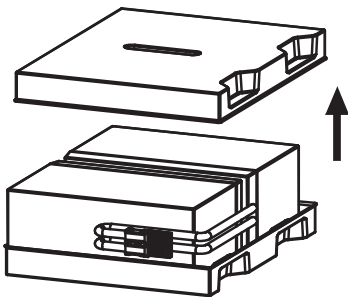

Remove the top cover of the battery box. See the opposite page for battery swap instructions for your model.

Step 5

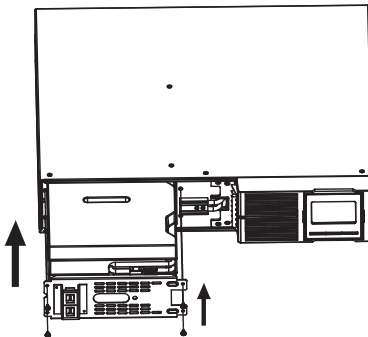

After swapping the batteries, replace the battery tray in the UPS and reattach the battery cover. Tighten the screws securely.

Step 6

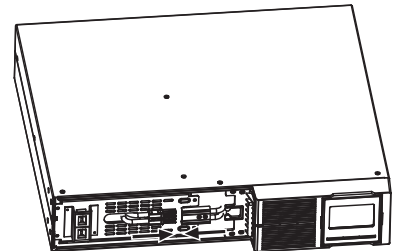

Reconnect the battery wires.

Step 7

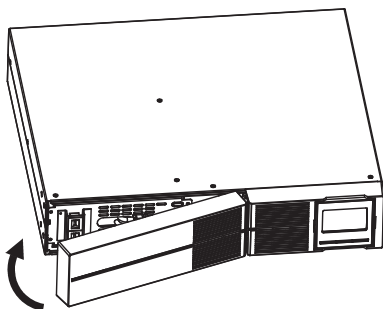

Replace the front panel cover.

WB-UPS-1100-8 TWO-BATTERY TRAY CONNECTION

Step 1

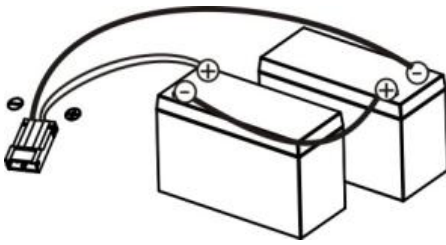

Replace the batteries in the tray. Wire the new batteries as shown above.

Step 2

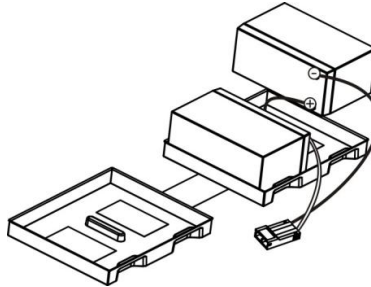

Place the new battery packs in the tray as shown above.

Step 3

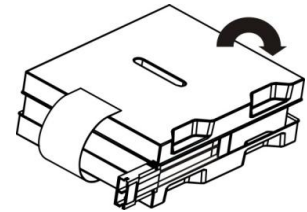

Place the cover back on the battery tray and reassemble the UPS.

WB-UPS-1500-4/ WB-UPS-2000-8 FOUR-BATTERY TRAY CONNECTION

Step 1

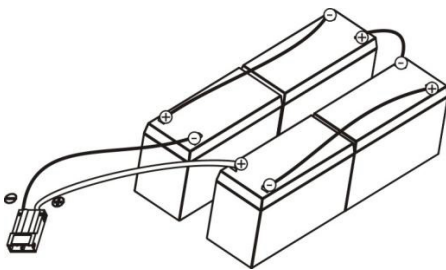

Replace the batteries in the tray. Wire the new batteries as shown above.

Step 2

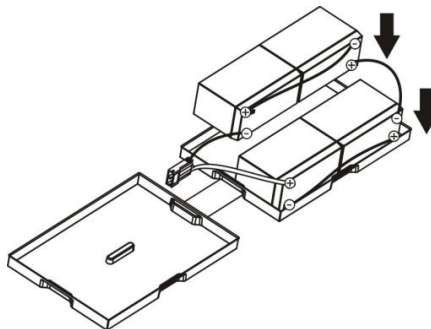

Place the new battery packs in the tray as shown above.

Step 3

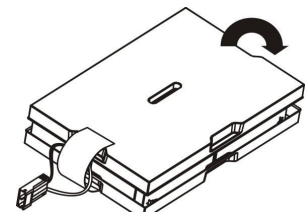

Place the cover back on the battery tray and reassemble the UPS.

SPECIFICATIONS

MODEL	WB-UPS-1100-8	WB-UPS-1500-8	WB-UPS-2000-8
CAPACITY	1100VA/990W	1500VA/1350W	1900VA/1710W @120V Output 1740VA/1566W @110V Output
INPUT			
Voltage	110/120V AC		
Acceptable Voltage Range	81-145V AC		
Frequency Range	60/50 Hz (Auto sensing)		
Power Outlet	NEMA 5-15	NEMA 5-20	
Power Inlet	IEC C14	IEC C20	
Surge Protection Modes	L-N, L-G, N-G		
Joule Rating (minimum)	1080J		
OUTPUT			
Output Voltage	110/120 VAC		
Outlet Quantity	(4) NEMA 5-15	(8) NEMA 5-15	(8) NEMA 5-20
Connections	USB, RS-232 (standard DE-9), slot for SNMP/AS400 card		
Voltage Regulation (Batt. Mode)	± 1.5% (before battery alarm)		
Frequency Range (Batt. Mode)	50 Hz or 60 Hz ± 1 Hz		
Current Crest Ratio	3:1		
Harmonic Distortion	2% max @ 100% linear load, 5% max @ 100% non-linear load (before low battery alarm)		
Transfer Time	Typical 2-6 ms, 10 ms max.		
Waveform (Batt. Mode)	Pure sinewave		
EFFICIENCY			
AC Mode	95%	96%	
Buck & Boost Mode	93%	94%	
Battery Mode	88%	90%	
BATTERY			
Type & Number	12 V/9AH x 2	12 V/9AH x 4	
Terminal Type	F2	F2	
Typical Recharge Time	4 hours recover to 90% capacity		
Charging Current (Max.)	1.5A	1.5A	1.5A
Charging Voltage	27.4V DC ± 1%	54.8V DC ± 1%	
PROTECTION			
Joule Ratings	Line-neutral: 158J*2; Line-ground: 264J*2; Neutral-ground: 264J*2; Total joule rating: 1372J		
INDICATORS			
LCD Display	AC Mode, Battery Mode, Load Level, Battery Level, Input Voltage, Output Voltage, Overload, Fault, and Low Battery		
ALARM			
Battery Mode	Sounds every 10 seconds		
Low Battery	Sounds every 2 seconds		
Overload	Sounds every 1 second		
Fault	Continuously sounding		
PHYSICAL			
Dimensions (WxHxD)	437.90 mm(17.24") x 87.88 mm (3.46") x 409.96 mm (16.14")	437.90 mm(17.24") x 87.88 mm (3.46") x 510.03 mm(20.08")	
Rack Mount	2 RU		
ENVIRONMENT			
Maximum Operating Temperature	40 °C (104° F)		
Humidity	0-90 % RH @ 0- 40 °C (Non-condensing)		
Noise Level	Less than 45dB		
MANAGEMENT			
Smart RS-232/USB	Supports Windows 2000/2003/XP/Vista/2008, Windows 7/8/10, Linux, Unix, and MAC		
Optional SNMP	Power management from SNMP manager and web browser		

IMPORTANT SAFETY INSTRUCTIONS

SAVE THESE INSTRUCTIONS

This manual contains important instructions that should be followed during installation and maintenance of the UPS and batteries.

Temperature Rating

Units are considered acceptable for use in a maximum ambient of 40 °C (104 °F).

For Pluggable Equipment

The socket-outlet shall be installed near the equipment and shall be easily accessible.

This UPS is equipped with internal batteries and only service person can replace the batteries.

When replacing batteries, replace with the same type and number of batteries or battery packs.

For UPS with Internally Mounted Battery

- a) Instructions shall carry sufficient information to enable the replacement of the battery with a suitable manufacturer and catalogue number.
- b) Safety instructions to allow access by Service Personnel shall be stated in the installation/service handbook.
- c) If batteries are to be installed by Service Personnel, instructions for interconnections, including terminal torque, shall be provided.

Replacement of Batteries Located in a Service Access Area

- A) Servicing of batteries should be performed or supervised by personnel knowledgeable about batteries and the required precautions.
- B) When replacing batteries, replace with the same type and number of batteries or battery packs.
- C) CAUTION: Do not dispose of batteries in a fire. The batteries may explode.
- D) CAUTION: Do not open or mutilate batteries. Released electrolyte is harmful to the skin and eyes. It may be toxic.
- E) CAUTION: A battery can present a risk of electrical shock and high short-circuit current. Contact with any part of a grounded battery can result in electrical shock. The following precautions should be observed when working on batteries:
 - a) Remove watches, rings, or other metal objects.
 - b) Use tools with insulated handles.
 - c) Wear rubber gloves and boots.
 - d) Do not lay tools or metal parts on top of batteries.
 - e) Disconnect charging source and load prior to installing or maintaining the battery.
 - f) Remove battery grounds during installation and maintenance to reduce likelihood of shock. Remove the connection from ground if any part of the battery is determined to be grounded.

WARRANTY

5-Year Limited Product Warranty

This WattBox product has a 5-Year Limited Product Warranty and a 5-Year Network Connectivity Warranty. The 5-Year Limited Product Warranty includes parts and labor repairs on all components found to be defective in material or workmanship under normal conditions of use. This warranty shall not apply to products which have been abused, modified, or disassembled. Products to be repaired under this warranty must be returned to the specified shipping location or a designated service center with prior notification and an assigned return authorization number (RA).

2-Year Limited Battery Warranty

The replaceable batteries in the WattBox UPS have a 2-year limited warranty against defects in material or workmanship under normal conditions of use. This warranty shall not apply to products which have been abused, modified, or disassembled.

5-Year Replacement Policy

Valid only in the United States and Canada. If your WattBox surge protector becomes damaged while protecting your connected equipment, you may request an equivalent replacement to the latest technology of that product category. Keep a copy of the original invoice to verify the date of purchase by the original buyer.

Warning Notice

WARRANTY LIMITATION FOR INTERNET PURCHASERS:

WattBox products purchased outside of the SnapAV or AisleEight internet website do not carry a valid Connected Equipment Protection Policy unless purchased from an authorized dealer.

CAUTION: Audio/Video, computer and/or telephone system installations can be very complex systems, which consist of many interconnected components. Due to the nature of electricity and surges, a single protector may not be able to completely protect complex installations. In those cases, a systemic approach using multiple protectors must be employed. Systemic protection requires professional design. AC power, satellite cables, CATV cables, or telephone/network lines entering the system that do not pass through this surge protector will render the connected equipment protection policy null and void. For additional information on how to protect your system, please contact WattBox before connecting your equipment to the surge protector.

WattBox Surge Protector Connected Equipment Protection Policy

Valid only in the United States and Canada. It is the policy of WattBox that it will, in its sole discretion, replace, pay to replace at fair market value, or pay to repair, up to the dollar amount specified, equipment that is damaged by an AC power, cable, telephone, or lightning surge while connected to a properly installed WattBox surge protector. WattBox must determine that the surge protector shows signs of surge damage or is operating outside of design specifications, relative to its surge protection capability, and under all of the circumstances failed to protect your connected equipment.

THIS POLICY IS SUBJECT TO THE CONDITIONS BELOW:

1. PROOF OF PURCHASE REQUIRED:

WattBox's connected equipment policy extends to the original purchaser of the WattBox product only and is non-transferable. Original purchase receipts must accompany any product return or claim for connected equipment damage.

2. PROPER INSTALLATION:

WattBox AC protectors must be directly plugged into a properly grounded 3-wire AC outlet. Extension cords, non-grounded two prong adapters, or other non-WattBox surge products must not be used. Building wiring and other connections to protected equipment must conform to applicable codes (NEC or CEC). No other ground wires or ground connections may be used. All wires (e.g., AC power lines, telephone lines, signal/data lines, coaxial cable, etc.) leading into the protected equipment must first pass through a single WattBox protector designed for the particular application. The protector and the equipment to be protected must be indoors in a dry location, and in the same building. WattBox installation instructions and diagrams must be followed.

3. NOTIFICATION:

You must notify WattBox within fourteen days of any event precipitating a request for product replacement or payment for connected equipment damage. A return authorization (RA) number must first be obtained from the WattBox Customer Service Department returning the protector to WattBox. At this time, you must notify WattBox if you believe you have a claim for damaged connected equipment.

Once you obtain an RA number, please mark the number on the bottom of the unit and pack it in a shipping carton/box with enough packing material to protect it during transit. The RA number must also be clearly marked on the outside of the carton. Ship the unit to WattBox. Please note that you are responsible for any and all charges related to shipping the unit to WattBox.

If connected equipment damage was indicated on your RA request, WattBox requests the make and model of all connected equipment, a connection diagram of your system, as well as other requests based on the extent of the request for product placement or payment for connected equipment damage. All requests by WattBox are to be completed and returned within 30 days. Be sure to note its configuration before disconnecting your equipment.

4. DETERMINATION OF FAILURE:

WattBox evaluates the protector for surge damage. The protector must show signs of surge damage or must be performing outside of design specifications relative to its surge protection capability. Opening the enclosure, tampering with, or modifying the unit in any way shall be grounds for an automatic denial of your request for payment. WattBox, after evaluating all information provided, shall, in its sole discretion, determine whether or not your request is eligible for payment.

If the surge protector shows no signs of AC power or signal line surge damage and is working within design specifications, WattBox will return the unit to you explaining the test results and notifying you of the rejection of your claim. WattBox reserves the right to inspect the damaged connected equipment, parts, or circuit boards. WattBox also reserves the right to inspect the customer's facility. Damaged equipment deemed uneconomical to repair must remain available for inspection by WattBox until the claim is finalized.

5. REQUEST PAYMENTS:

Once WattBox has determined that you are entitled to compensation, WattBox will, at its election, pay you the present fair market value of the damaged equipment, or pay for the cost of the repair, or send you replacement equipment, or pay the equivalence of replacement equipment.

6. OTHER INSURANCE/WARRANTIES:

This coverage is secondary to any existing manufacturer's warranty, implied or expressed, or any insurance and/or service contract that may cover the loss.

7. EXCLUSIONS:

THE WattBox SURGE PROTECTOR EQUIPMENT POLICY DOES NOT APPLY TO: Service charges, installation costs, reinstallation costs; setup cost; diagnostic charges; periodic checkups; routine maintenance; loss of use of the product; costs or expenses arising out of reprogramming or loss of programming and/or data; shipping charges or fees; service calls; loss or damage occasioned by fire, theft, flood, wind, accident, abuse or misuse; and products subject to manufacturer's recall or similar event.

8. DISPUTE RESOLUTION:

Any controversy or claim arising out of or relating to WattBox's Surge Protector Equipment Policy, or the alleged breach thereof, shall be settled by arbitration administered by the American Arbitration Association under its Commercial Arbitration Rules. You may file for arbitration at any AAA location in the United States upon the payment of the applicable filing fee. The arbitration will be conducted before a single arbitrator, and will be limited solely to the dispute or controversy between you and WattBox. The arbitration shall be held in any mutually agreed upon location in person, by telephone, or online.

Any decision rendered in such arbitration proceedings will be final and binding on each of the parties, and judgment may be entered thereon in a court of competent jurisdiction. The arbitrator shall not award either party special, exemplary, consequential, punitive, incidental or indirect damages, or attorney's fees. The parties will share the costs of arbitration (including the arbitrator's fees, if any) in the proportion that the final award bears to the amount of the initial claim.

9. GENERAL

If you have any questions regarding the product warranty or the connected equipment protection policy, please contact the WattBox Customer Service Department. This warranty supersedes all previous warranties. This is the only warranty provided with the protector and any other implied or expressed warranties are nonexistent. This warranty may not be modified except in writing, signed by an officer of the SnapAV Corporation.

Copyright ©2020, Wirepath Home Systems, LLC. All rights reserved. Control4 and Snap AV and their respective logos are registered trademarks or trademarks of Wirepath Home Systems, LLC, dba "Control4" and/or dba "SnapAV" in the United States and/or other countries. 4Store, 4Sight, Control4 My Home, Snap AV, Araknis, Autonomic, BakPak, Binary, Dragonfly, Episode, Luma, Mockupancy, Nearus, NEEO, OvrC, Pakedge, Sense, Strong, SunbriteTV, Triad, Visualant, WattBox, and Wirepath are also registered trademarks or trademarks of Wirepath Home Systems, LLC. Other names and brands may be claimed as the property of their respective owners. All specifications subject to change without notice.

WATT BOX

200427-1016